

Registered Office: Tel : 91 44 2811 2472
" Maithri " URL : www.ranegroup.com
132, Cathedral Road,
Chennai 600 086.
India.

CIN : L35999TN1936PLC002202

Rane Holdings Limited



//Online submission//

RHL/SE/058/2024-25

November 07, 2024

BSE Limited Listing Centre Scrip Code: 505800	National Stock Exchange of India Ltd. NEAPS Symbol: RANEHOLDIN
--	---

Dear Sir / Madam,

Sub: Earnings Presentation – Q2 FY25

Ref: Our letter no. RHL/SE/055/2024-25 dated November 04, 2024

This is with reference to the aforementioned letter intimating Earnings Conference Call scheduled on **Friday, November 08, 2024 at 15:00 hours (IST)**, inter alia, to discuss the unaudited financial results for the quarter and half year ended September 30, 2024. We enclose herewith copy of the Earnings presentation proposed to be made thereat, to the analyst and investors.

The presentation, audio / video recordings (if any) and transcript are being made available as per the prescribed timelines on the investor information section website of the Company at the web-link <https://ranegroup.com/investors/rane-holdings-limited/>.

We request you to take the above on record and note the compliance with SEBI (Listing Obligations and Disclosure Requirements) Regulations, 2015 (SEBI LODR).

Thanking you,

Yours faithfully,

For **Rane Holdings Limited**

Siva Chandrasekaran
Secretary

Encl: a/a



Rane Group

Earnings Presentation | Q2 FY25

Table of Contents



Q2 FY25 Financial & Operational Performance

Rane Group Overview



Rane Group

Q2 FY25 Financial & Operational Performance



To become the Preferred Trusted Supplier of Safety & Critical Auto Components

Strategic pillars of growth

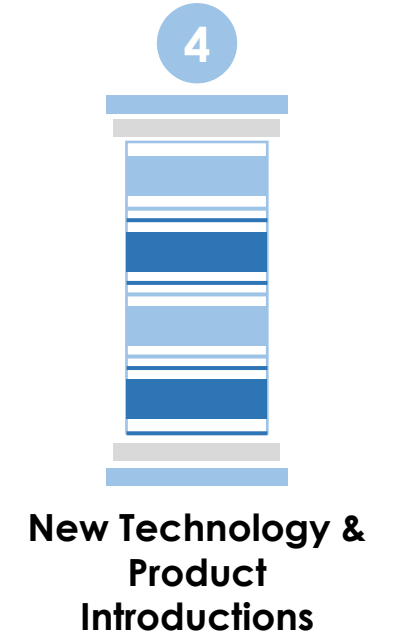
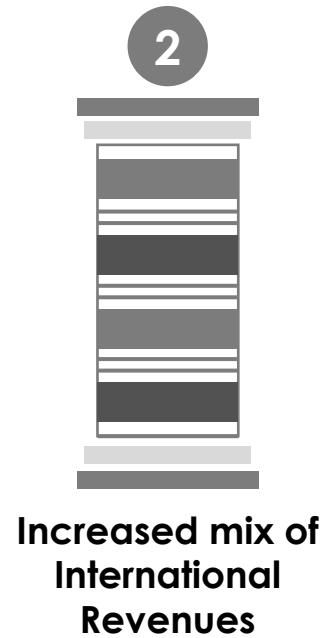

Business Drivers

- › **92%+ of revenue comes from powertrain agnostic products**
- › **Continued dominance on domestic market across major products**
- › **Increasing export mix for steering & linkages, valve train components and occupant safety products**
- › **Renewed focus on Aftermarket segment leveraging group level synergy**
- › **Continuous new product introductions leveraging strong in-house engineering capabilities**
- › **Increasing efficiencies across manufacturing facilities through operational excellence and digitalization.**

RANE BRAKE LINING

- Won Rs. 12 Cr order from various customers (incl. Rs. 1.50 Cr from international customers)

RANE (MADRAS)

- Won Rs. 140 Cr order from international customers
- Won orders worth Rs. 30 Cr from domestic customers (incl. 25 Cr for EV applications)

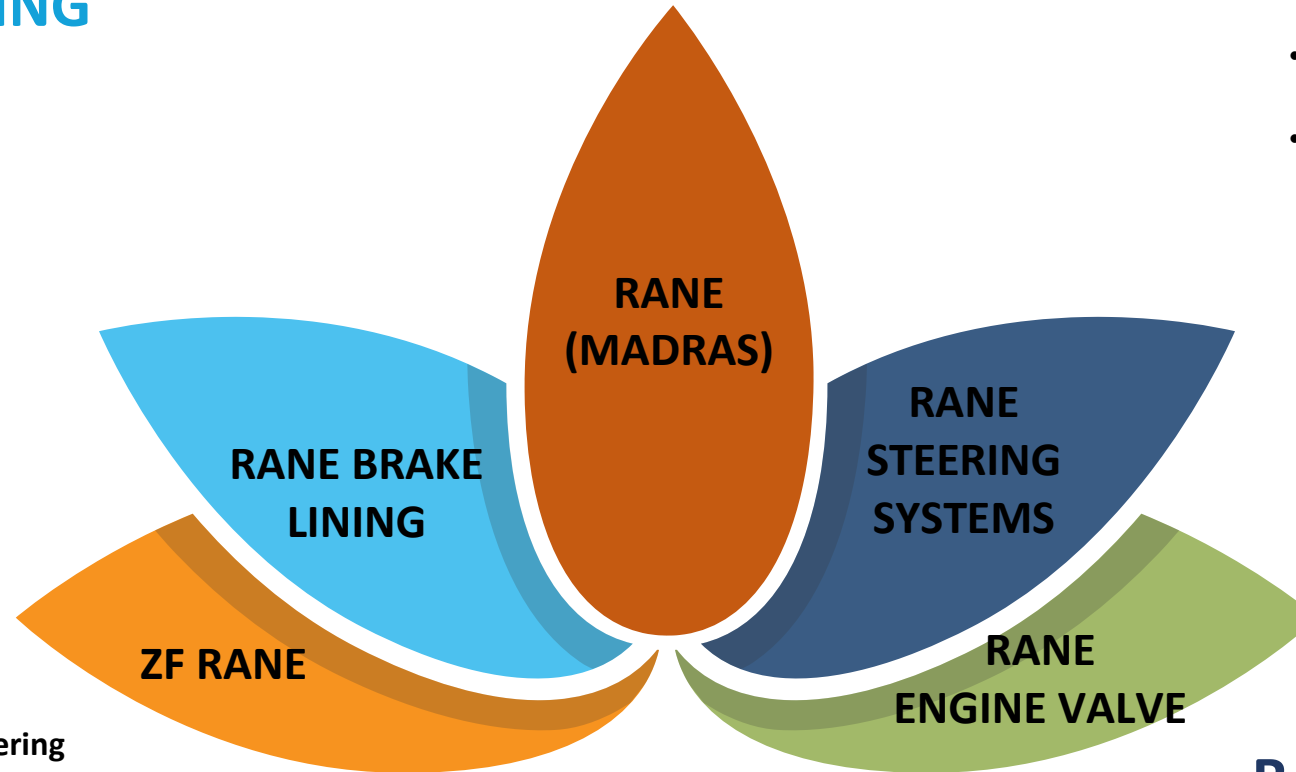

ZF RANE

- Won orders worth Rs. 26 Cr for steering products from various domestic CV customers (incl. Rs. 7 Cr for EV application)
- Won orders worth Rs. 5 Cr from global PV customer for airbags

RANE ENGINE VALVE





- Won Rs. 5 Cr order from domestic passenger vehicle customer

RANE STEERING SYSTEMS

- Won orders worth Rs. 1 Cr for Steering Column for domestic LCV applications

During the quarter new business won of Rs. 220 Cr

Group Domestic OE Sales vs. Industry Growth

Industry Performance Review (Q2 FY25)	 Passenger Vehicle	 commercial Vehicle	 Farm Tractor	 2-Wheeler
Production YoY Growth# in %	-1%	-14%	3%	13%
Rane Group Sales Growth YoY in % (India OEM)	5%	-18%	-18%	-4%
Rane Group Revenue Split * (India OEM)	67%	22%	5%	3%
	<ul style="list-style-type: none"> Higher growth than the industry driven by higher growth on served models 	<ul style="list-style-type: none"> Performance is lower than industry due to higher drop in served models 	<ul style="list-style-type: none"> Higher shift to power steering and lower offtake of manual tractors 	<ul style="list-style-type: none"> Lower performance is due to lower offtake in served models.

* Other segments such as Rail, Defence, Stationary Engines and 3-Wheeler contribute around 3%

Market Commentary

- The PV segment faced challenges due to subdued consumer sentiment and high inventory levels. However the MUV segment continued to perform well.
- The declining trend in the CV segment continued in Q2 FY25 due to slowdown in infrastructure projects
- The growth in the Farm Tractor segment is supported by positive rural sentiment following a surplus monsoon.
- The 2W segment continued its strong performance, driven by robust demand from both rural and urban markets, supported by accessible financing options.

Group Aggregate Sales (Q2 FY25)

Group Aggregate Sales (Rs cr.)

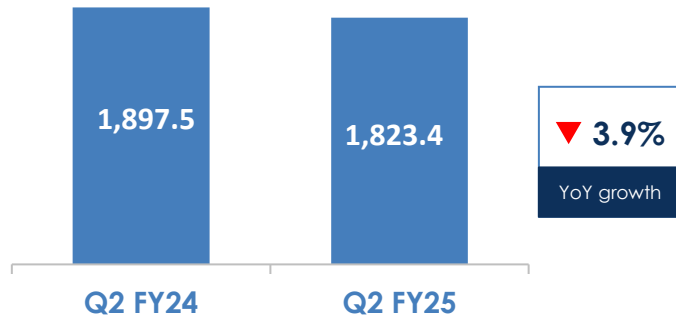

- › Sales decreased by 3.9% from Rs. 1,897.5 Cr in Q2 FY24 to Rs. 1,823.4 Cr in Q2 FY25
- Revenue from Indian OE customers declined by 3%. Lower offtake from FT and CV customers
- Revenues from International customers decreased 10% predominantly on account of divestment of LMCA business. On an organic basis it declined by 2% due to lower offtake of steering products particularly in the ATV segment
- Revenue from Indian aftermarket segment increased by 5%

Group Aggregate Sales (Q2 FY25)

BY PRODUCT (%)

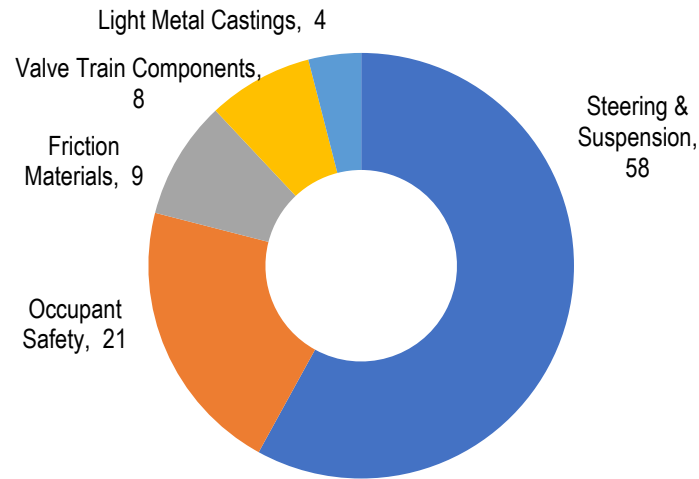

BY MARKET (%)

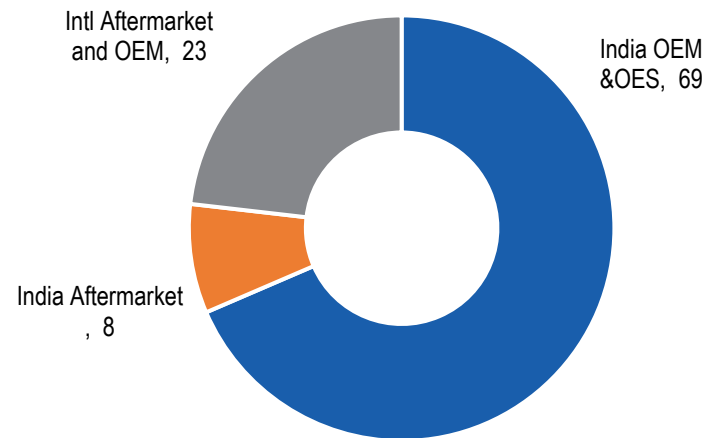

BY VEHICLE SEGMENT (%)

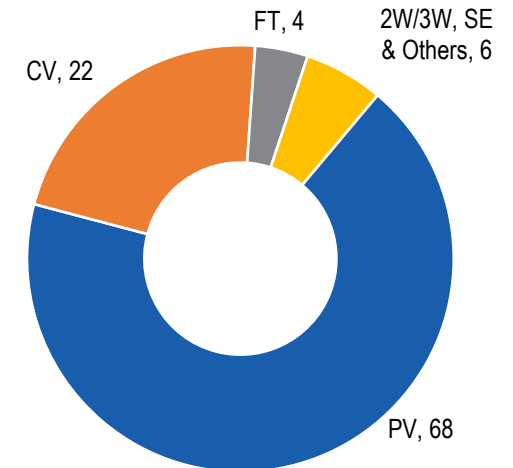

Q2 FY25 numbers are strictly not comparable due to divestment of LMCA on 14th Sep'23.

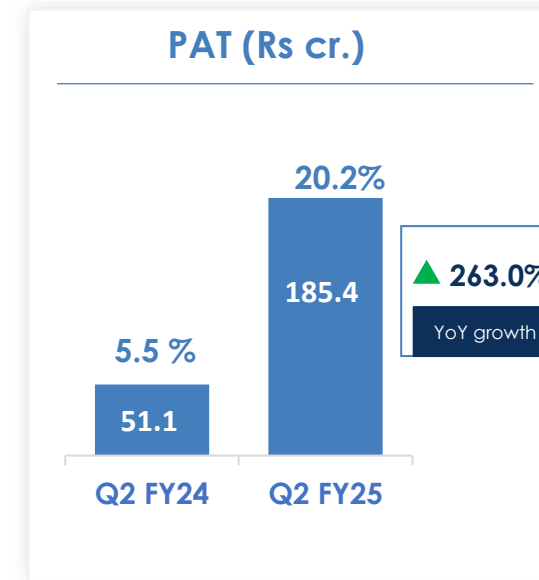
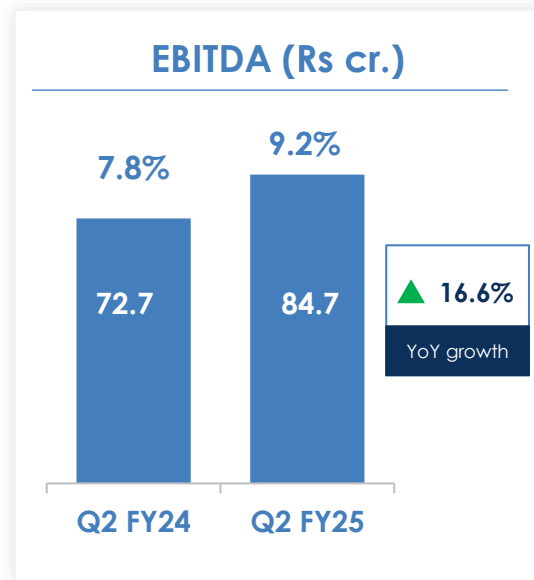
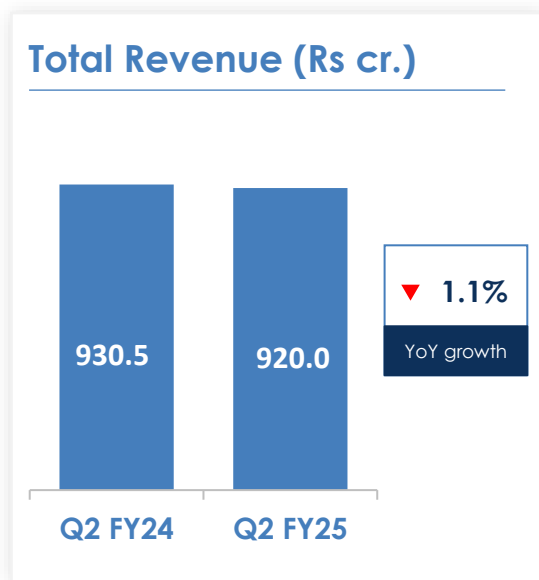

› **Total Revenue decreased by 1.1% from Rs. 930.5 Cr in Q2 FY24 to Rs. 920 Cr in Q2 FY25**

— RSSL (formerly known as RNSS) has become wholly owned Subsidiary of RHL effective from 19th September 2024

› **EBITDA increased by 16.6% from Rs. 72.7 Cr in Q2 FY24 to Rs. 84.7 Cr in Q2 FY25**

— EBITDA margin increased 140 bps supported by various cost savings initiatives

› **PAT increased by 263.0% from Rs.51.1 Cr in Q2 FY24 to Rs. 185.4 Cr in Q2 FY25**

— Exceptional items mainly represent amount received by RSSL towards settlement of various claims and gain arising from the remeasurement of the existing stake of RSSL at fair value

Rane (Madras) Limited

Q2 FY25 Financial & Operational Performance

Business Drivers

- › Challenging demand environment in India due to decline in the commercial vehicle and farm tractor segment
- › Exports was impacted due to drop in ATV segment

Operational Highlights

- › Won “Sustainability Excellence” award from Tata Motors
- › RML-SLD has been awarded the Green Product Ecolabel certification for its Steering Linkages product by the CII
- › Launched fossil-free tie rods - linkages for the Volvo Group

Business Split (Q2 FY25) – RML India

BY MARKET (%)

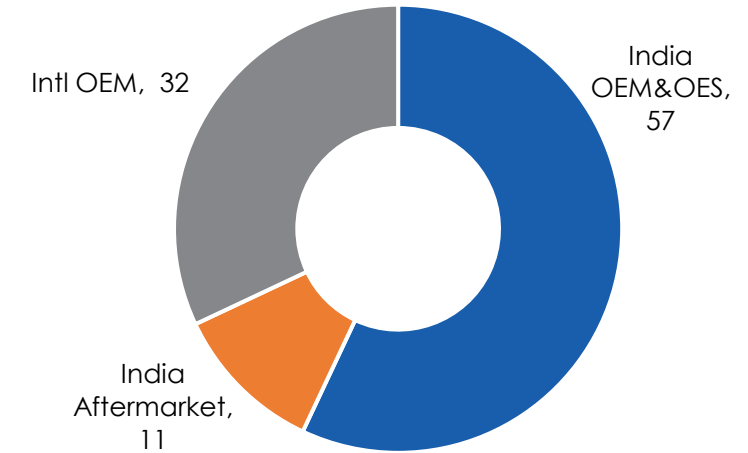

BY VEHICLE SEGMENT (%)

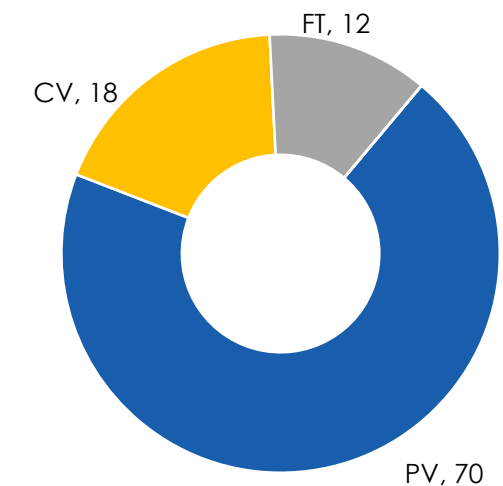

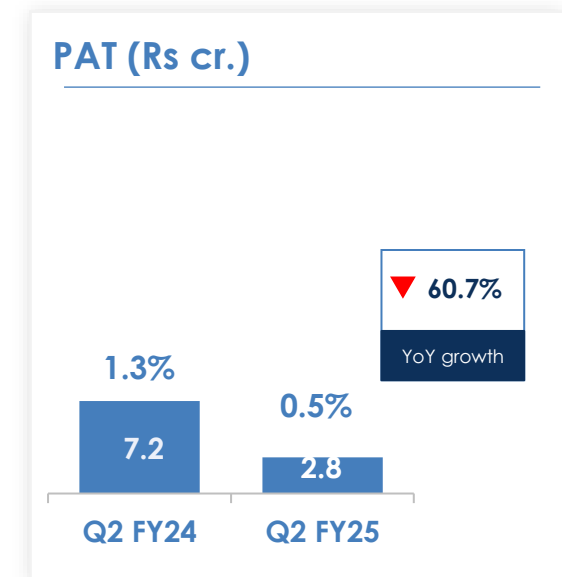
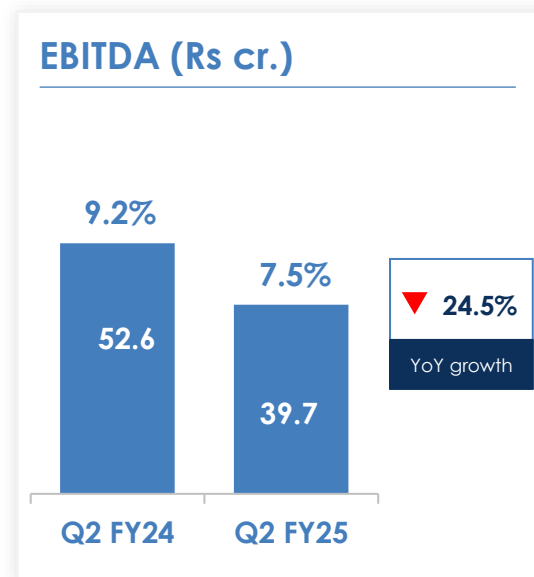
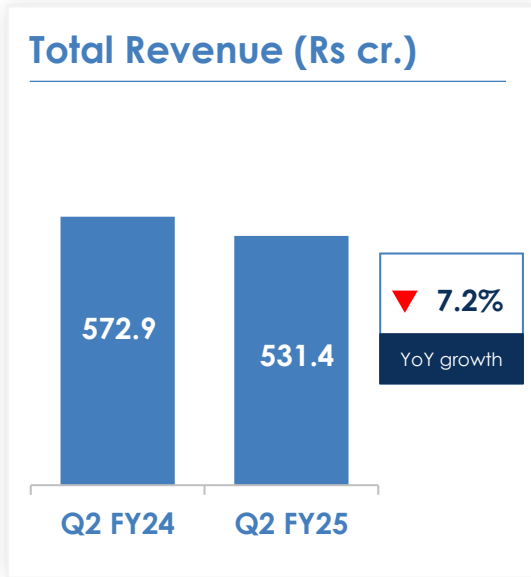

› **Total Revenue decreased by 7.2% from Rs. 572.9 Cr in Q2 FY24 to Rs. 531.4 Cr in Q2 FY25**

- Sales to Domestic OE customers declined by 10%. Lower offtake from FT and CV customers.
- Export Sales declined by 6%. Lower off-take of steering products particularly in the ATV segment.
- Sales to Indian Aftermarket customers had muted growth.

› **EBITDA decreased by 24.5% from Rs. 52.6 Cr in Q2 FY24 to Rs. 39.7 Cr in Q2 FY25**

- EBITDA margin declined by 171 bps. Lower material cost was offset by certain one-off provisions.

› **PAT decreased by 60.7% from Rs. 7.2 Cr in Q2 FY24 to Rs. 2.8 Cr in Q2 FY25**

Total Revenue (Rs cr.)

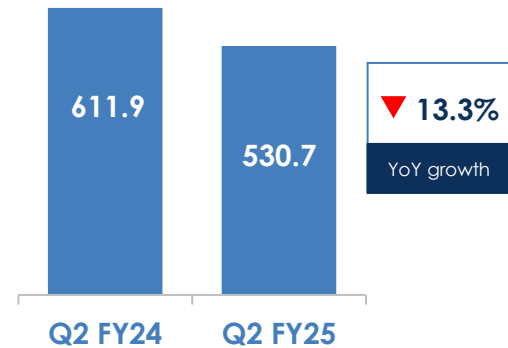

EBITDA (Rs cr.)

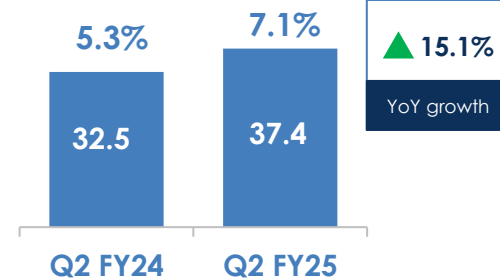

PAT (Rs cr.)

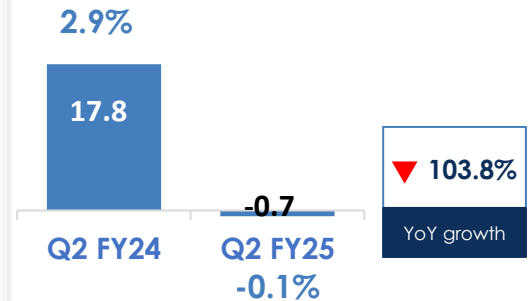

- › Total Revenue decreased by 13.3% from Rs. 611.9 Cr in Q2 FY24 to Rs. 530.7 Cr in Q2 FY25
- › EBITDA increased by 15.1% from Rs. 32.5 Cr in Q2 FY24 to Rs. 37.4 Cr in Q2 FY25
- › PAT decreased by 103.8% from Rs. 17.8 Cr in Q2 FY24 to a loss of Rs. 0.7 Cr in Q2 FY25
- In Q2 FY'24, recorded a fair value loss on overseas investment for Rs. 85.5 Cr and also created a Deferred Tax Asset of Rs. 113.3 Cr.



Rane Engine Valve Limited

Q2 FY25 Financial & Operational Performance



Business Drivers

- › 42% of revenue generated from EV insulated segment
- › Sustained financial improvement

Operational Highlights

- › Trichy and Tumkur facilities received TPM Significant achievement award from CII
- › Aziz Nagar facility received TPM Strong commitment award from CII
- › Received “Zero Defect Supplies” award from Toyota Industries Engine India

Business Split (Q2 FY25)

BY MARKET (%)

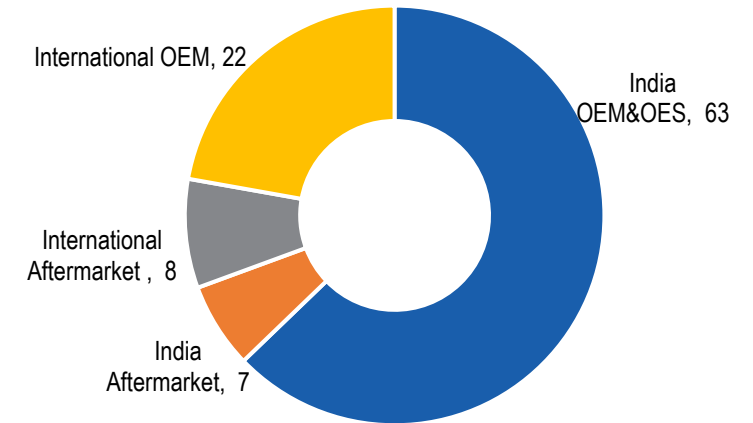

BY VEHICLE SEGMENT (%)

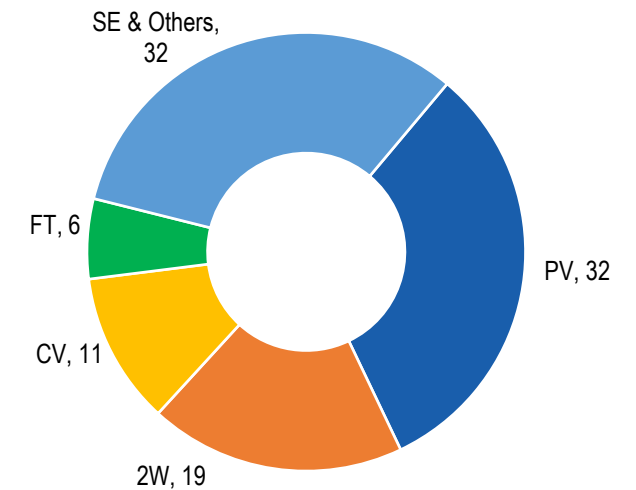

Total Revenue (Rs cr.)

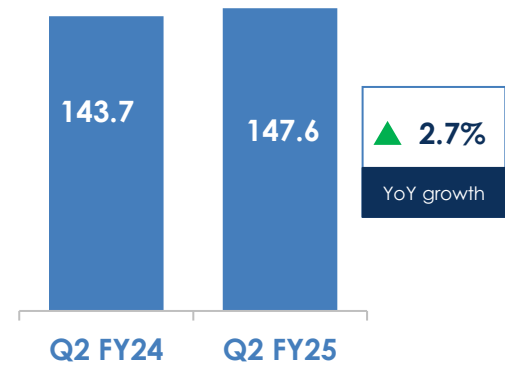

EBITDA (Rs cr.)

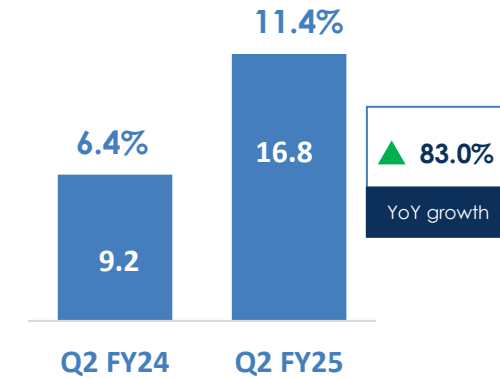

PAT (Rs cr.)

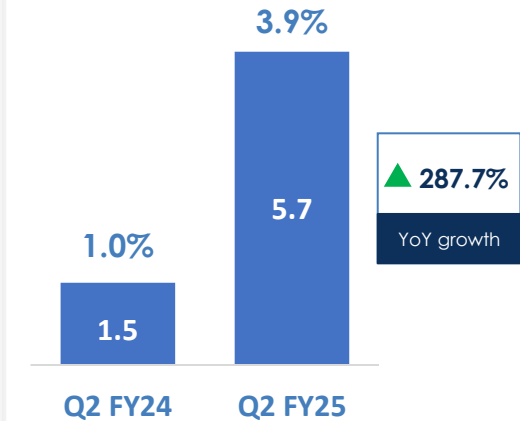

› **Total Revenue increased by 2.7 % from Rs. 143.7 Cr in Q2 FY24 to Rs. 147.6 Cr in Q2 FY25**

- Sales to India OE customers grew by 12% supported by strong off-take from Passenger Vehicle customers.
- Export Sales declined by 9%. Demand from export customers remained weak.
- Sales to Indian Aftermarket customers declined by 3%.

› **EBITDA increased by 83.0% from Rs. 9.2 Cr in Q2 FY24 to Rs. 16.8 Cr in Q2 FY25**

- Favourable material price and other cost savings initiatives helped improve EBITDA margin by 501 bps

› **PAT increased by 287.7% from Rs. 1.5 Cr in Q2 FY24 to Rs. 5.7 Cr in Q2 FY25**



Rane Brake Lining Limited

Q2 FY25 Financial & Operational Performance



Business Drivers

- › Market leader in Passenger Vehicle segment and increased penetration in two wheeler segment
- › Strong presence in Aftermarket segment
- › Expanding the International Aftermarket segment

Operational Highlights

- › Received Green Championship award from the Tamil Nadu Pollution Control Board
- › “Energy Efficient Unit” Award from CII in the 25th National Award for Excellence in Energy Management - 2024

Business Split (Q2 FY25)
BY MARKET (%)

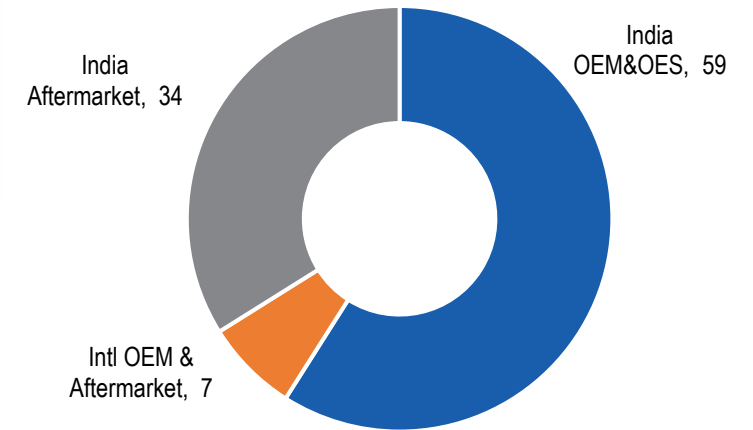

BY VEHICLE SEGMENT (%)

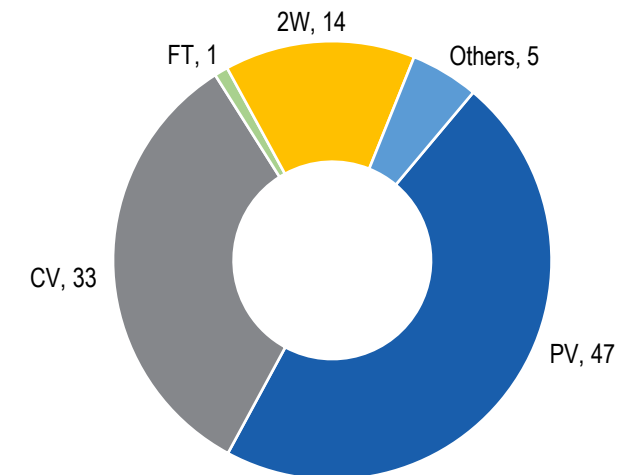

Total Revenue (Rs cr.)



EBITDA (Rs cr.)

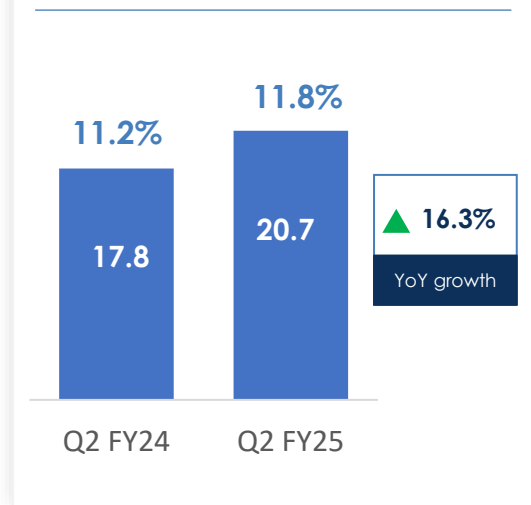

PAT (Rs cr.)

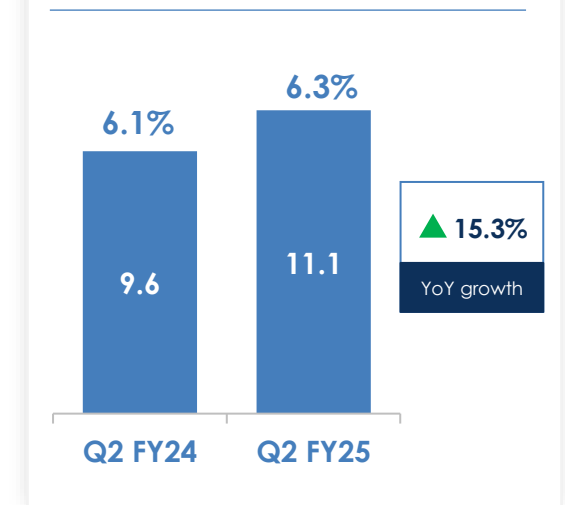

› **Total Revenue increased by 10.7% from Rs. 158.2 Cr in Q2 FY24 to Rs. 175.1 Cr in Q2 FY25**

- Sales to OE customer grew 7%. Strong growth driven by demand from passenger vehicle and rail segments.
- Sales to Aftermarket customers grew 11%.
- Export sales grew 35%. Strong orders from US and other served regions.

› **EBITDA increased by 16.3% from Rs. 17.8 Cr in Q2 FY24 to Rs. 20.7 Cr in Q2 FY25**

- EBITDA margin grew by 57 bps on account of favourable product mix was partially offset by unfavourable forex. There was one-off provision reversal during Q2 FY'24.

› **PAT increased by 15.3% from Rs. 9.6 Cr in Q2 FY24 to Rs. 11.1 Cr in Q2 FY25**

Rane Steering Systems Private Limited

(formerly known as Rane NSK Steering Systems Private Limited)

Q2 FY25 Financial & Operational Performance

Business Drivers

- › EPS - Drop in passenger car segment impacted overall passenger vehicle volume
- › Lower commercial vehicle volume impacted Manual Steering Column product

Operational Highlights

- › RHL acquired 51% stake in RSSL from NSK (Japan) and consequently RSSL became wholly owned subsidiary of RHL w.e.f 19th September 2024.
- › Chennai Plant won the CII National award for Excellence in Energy Management

Business Split (Q2 FY25)

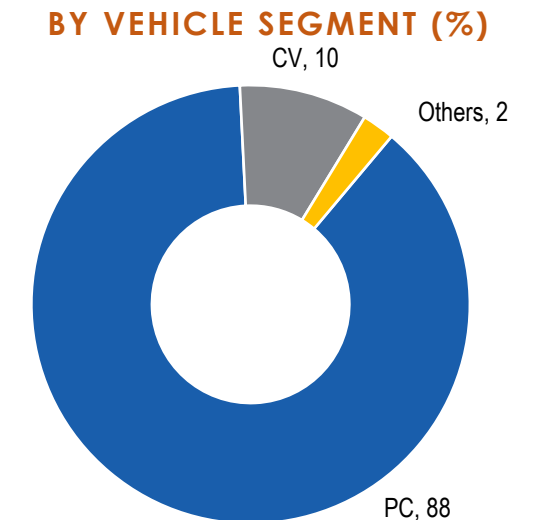
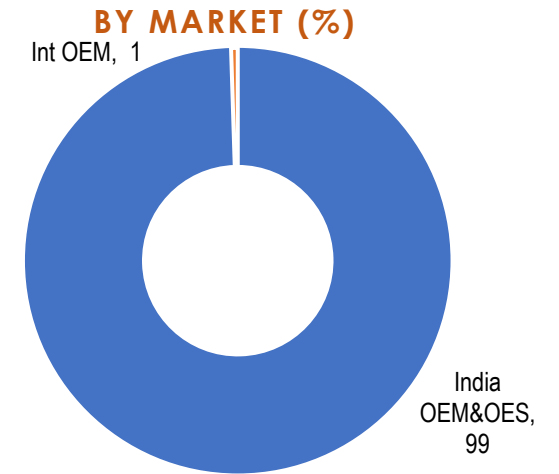

Total Revenue (Rs cr.)

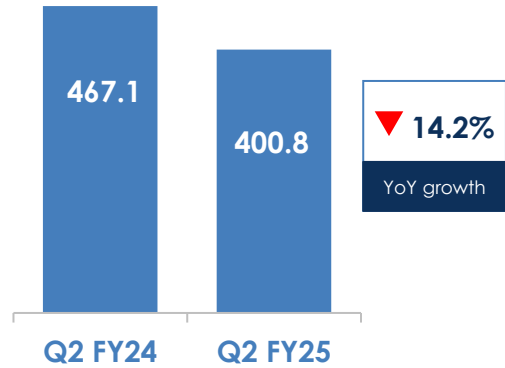

EBITDA (Rs cr.)

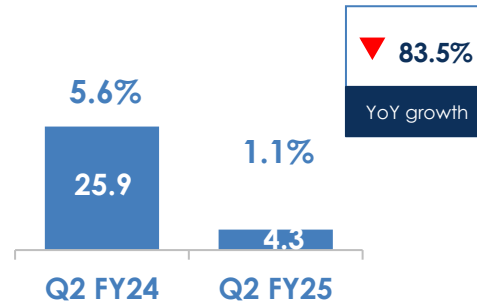

PAT (Rs cr.)

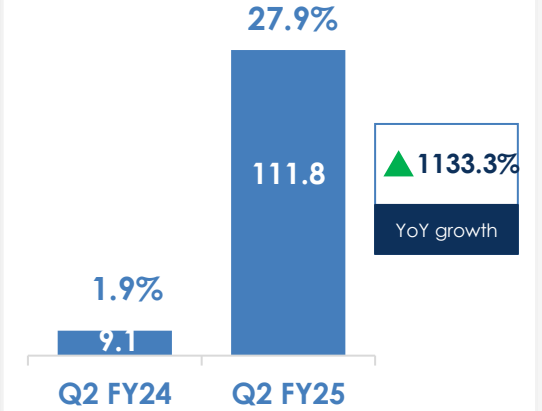

› **Total Revenue decreased by 14.2% from Rs. 467.1 Cr in Q2 FY24 to Rs. 400.8 Cr in Q2 FY25**

— Drop in passenger car segment impacted the sales

› **EBITDA decreased by 83.5% from Rs. 25.9 Cr in Q2 FY24 to Rs. 4.3 Cr in Q2 FY25**

— Adverse mix and increase in material cost impacted the profitability

› **PAT increased by 1133.3% from Rs. 9.1 Cr in Q2 FY24 to Rs. 111.8 Cr in Q2 FY25**

— Exceptional income of Rs. 176 Cr recognised during Q2 FY'25 towards settlement amount received from NSK Ltd. (Japan)

ZF Rane Automotive India Private Limited

Q2 FY25 Financial & Operational Performance

Business Drivers

- › Drop in Commercial Vehicle segment impacted steering division
- › Occupant safety division benefited from increased preference for safer cars and sustained growth in exports

Operational Highlights

- › ZRAI-OSD inaugurated Inflator Plant and Sled Test Facility in Trichy
- › ZRAI-OSD won Quality Excellence award from Tata Motors Passenger Vehicles Limited (TMPV) and Tata Passenger Electric Mobility Limited (TPEM)
- › ZRAI-OSD won first prize in the 19th ACMA National Level QC Competition. This achievement was executed by a dedicated team of young women operators from Trichy plant.

Business Split (Q2 FY25)

BY MARKET (%)

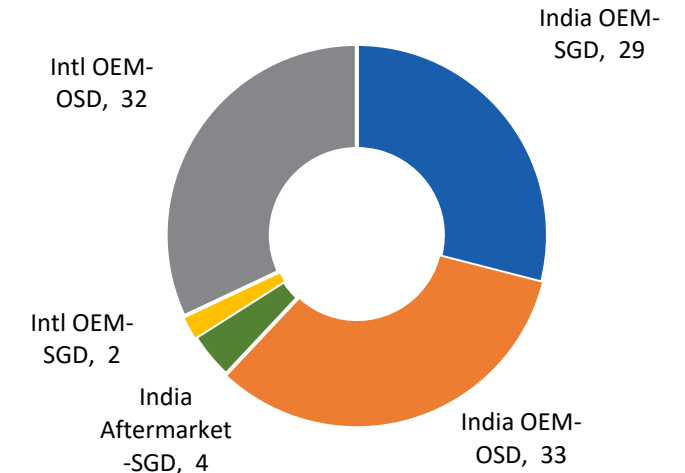

BY VEHICLE SEGMENT (%)

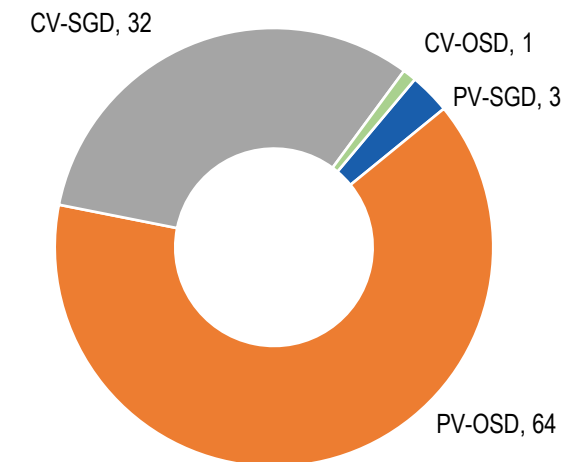

Total Revenue (Rs cr.)



EBITDA (Rs cr.)



PAT (Rs cr.)



› **Total Revenue increased by 9.3% from Rs. 552.1 Cr in Q2 FY24 to Rs. 603.5 Cr in Q2 FY25**

- Revenue from steering gear products decreased 14% due to drop in commercial vehicle segment
- Revenue from occupant safety systems grew 28% supported by strong offtake from domestic customers

› **EBITDA increased by 23.7% from Rs. 54.4 Cr in Q2 FY24 to Rs. 67.3 Cr in Q2 FY25**

- EBITDA margin improved 128 bps driven by operational leverage and favourable forex

› **PAT decreased by 6.0% from Rs. 23.4 Cr in Q2 FY24 to Rs. 22.0 Cr in Q2 FY25**



Rane Group

About Us



Founded in 1929 and headquartered in Chennai, Rane Group is one of the preferred OE manufacturer and supplier for global auto majors



The Group serves a variety of industry segments: Passenger Vehicles, Commercial Vehicles, Farm Tractors, Two-wheelers, Three-wheelers, Railways and Stationary Engines



Manufactures Steering and Suspension systems, Friction materials, Valve train components, Occupant safety systems and Light metal casting products.

REVENUE BY MARKET (%)

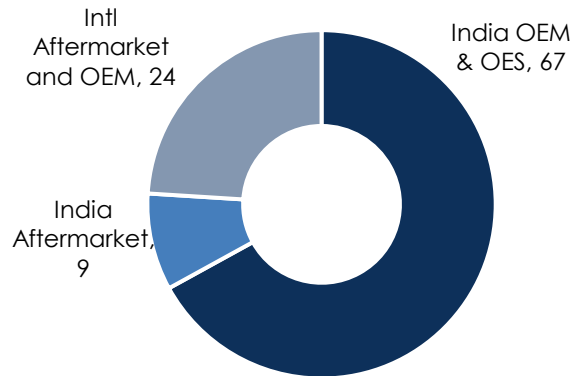

REVENUE BY VEHICLE SEGMENT (%)

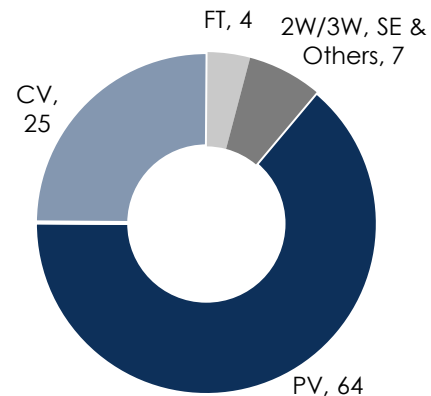

GROUP SALES OF INR 7,199 CR (~USD 870 MN)-FY'24

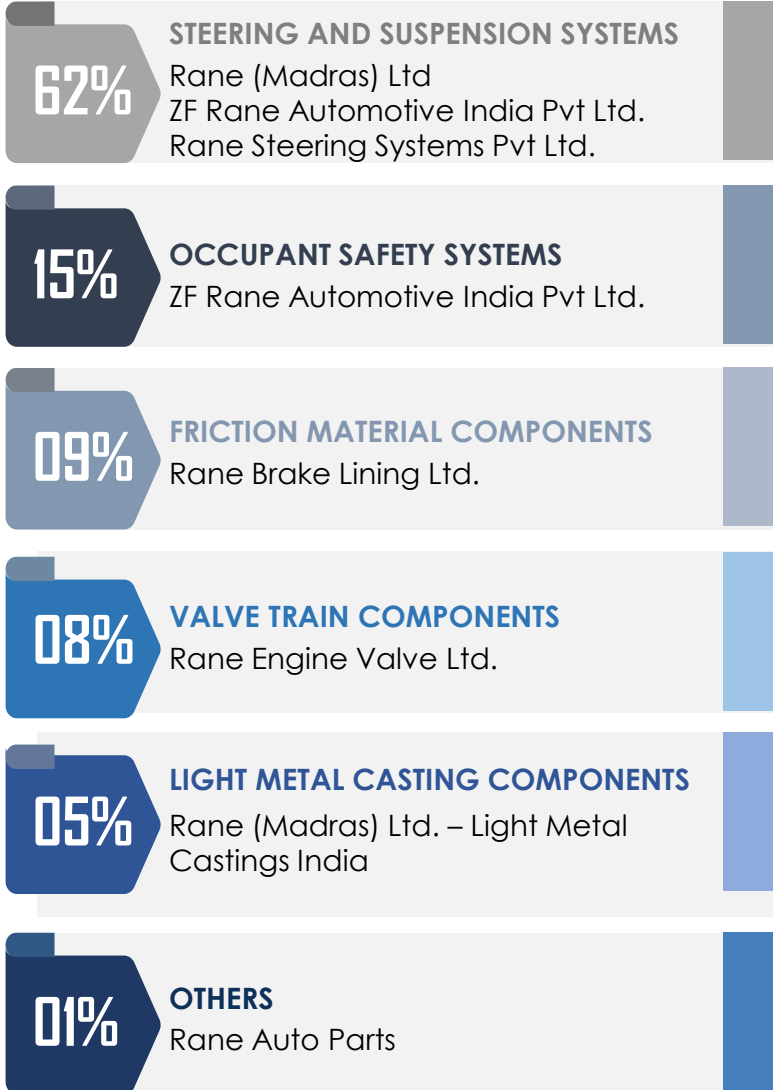



Listed

Share holding as on 30 September 2024

- Market leader in steering gear and steering linkage products in India. We have started catering to hydraulic products such as HSU and steering cylinders.
- Best in class manufacturing facilities at Chennai, Mysore, Puducherry and Pant Nagar.
- End to end testing facilities in house to validate the products' functional, endurance and environmental parameters.

PRODUCTS



MANUFACTURING PLANT

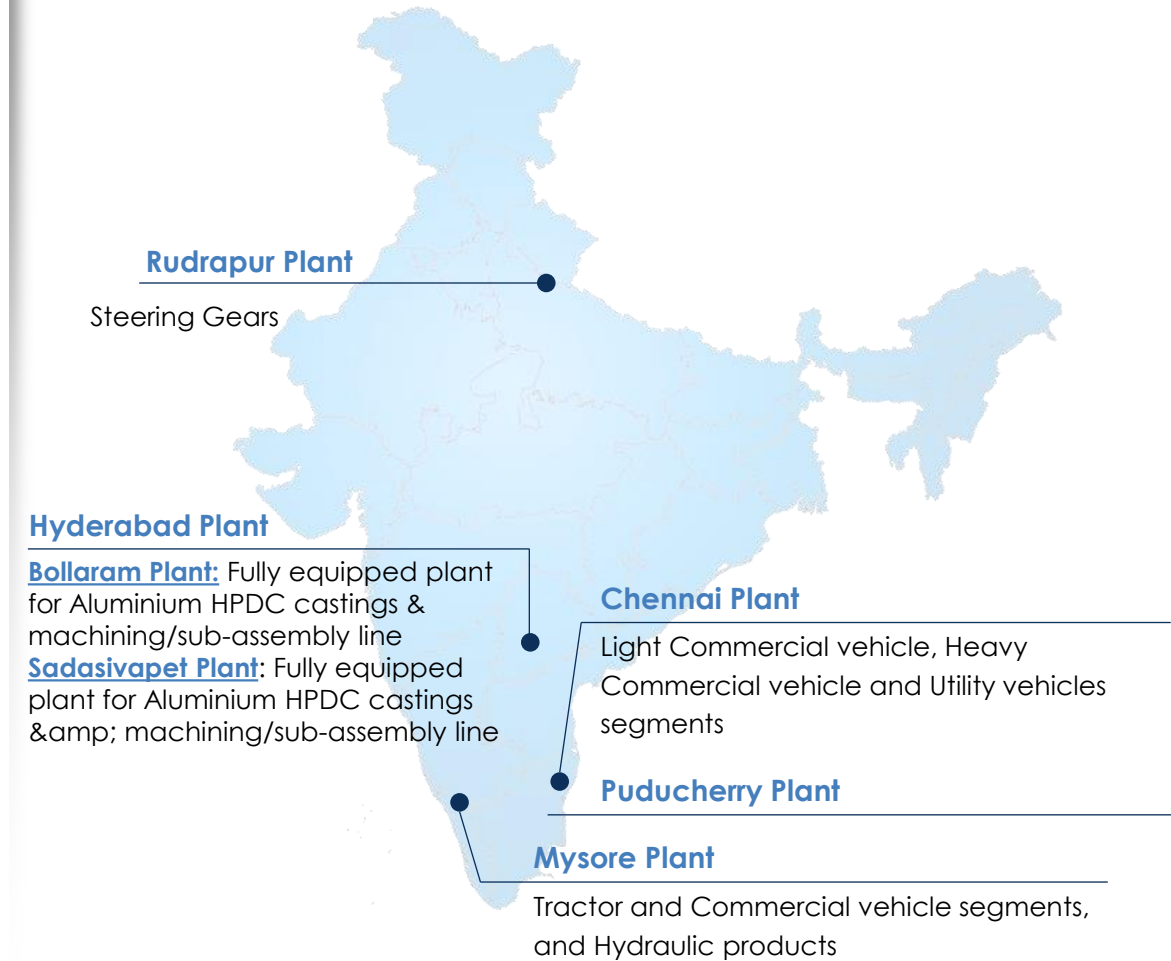

- Incepted In 1959, REVL manufactures valves and valve train components for various engine applications
- Non Automotive applications such as power generation, marine, defence, locomotive, etc.
- Comprehensive test laboratory for material characterisation, simulated test rigs and engine dynamometer test facility.

PRODUCTS

Engine Valves



Valve Guides



Mechanical Tappets



MANUFACTURING PLANT



Hyderabad Plants (2)

Small Valves for 2W and PC
Medium Valves for PC, Industrial and CV

Tumakuru Plant

Medium Valves for CV and Farm Tractors
Large & Extra Large Valves for Industrial, Power Generation and Marine Applications

Chennai Plant

Small Valves for 2W and PC
Medium Valves for Tractors and PC Guides, Tappets

Trichy Plant

Small & medium Valves for 2W, PC and CV

- Established in 1964, RBL is a leader in Friction Products across OEM segments and supplies products to over 15 countries
- Technical collaboration with Nisshinbo Brakes Inc. and TMD Friction
- Library of widely tested and approved formulations to suit diverse market / customer requirements.
- State-of-the-art R&D center equipped with full scale inertia dynamometer, static mu-measurement and NVH study rig.

PRODUCTS

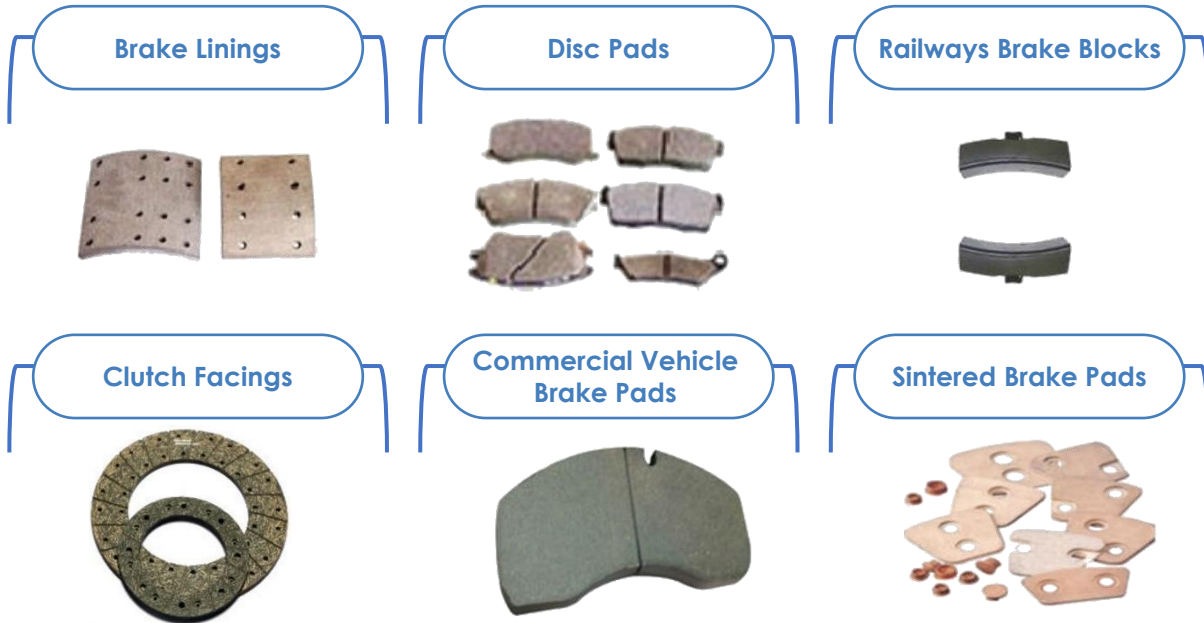

MANUFACTURING PLANT

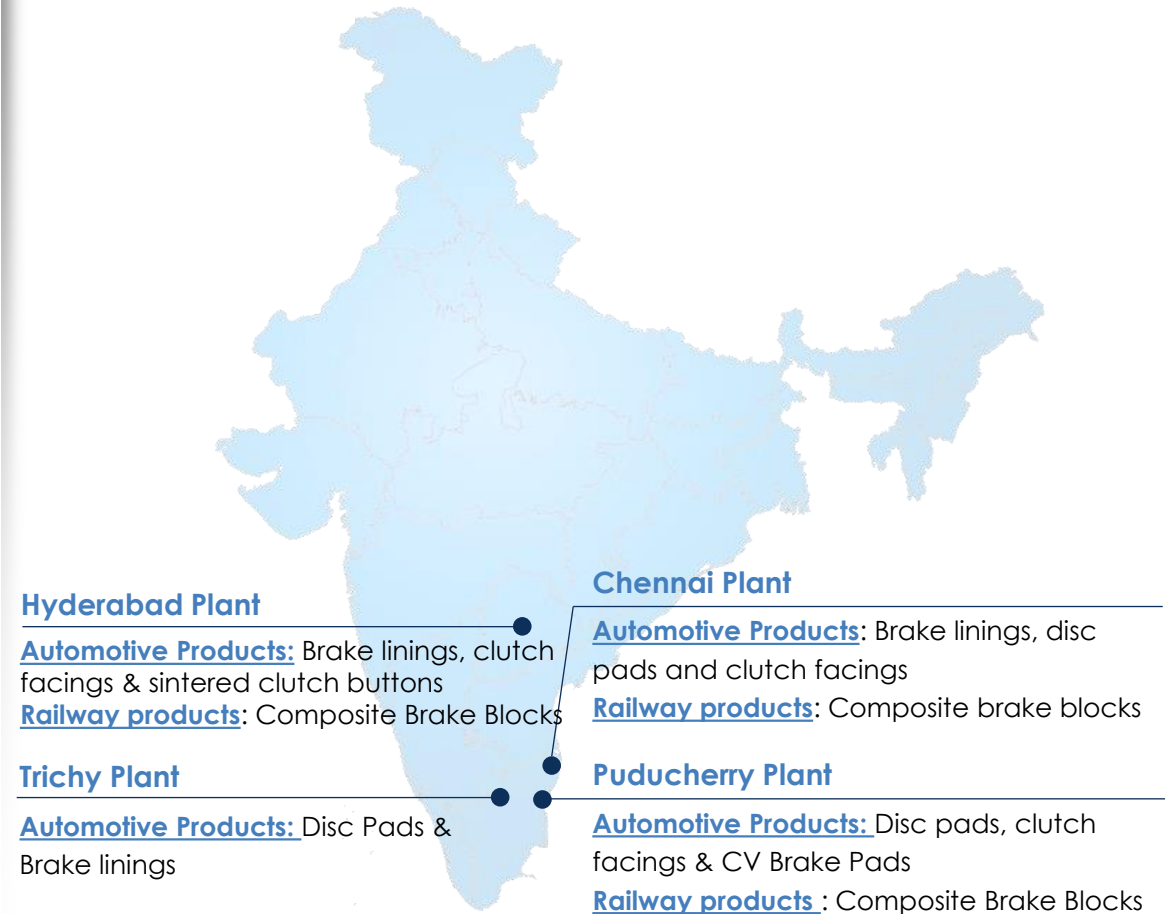

- State-of-art R&D test lab for validation of steering columns.
- Manufacturing facilities across four locations in Chennai, Bawal, Rudrapur & Ahmedabad.
- Design & Development capability for solid & energy absorbing columns. Development and application capability for EPS.
- Driver comfort, Passenger safety, Ergonomics and NVH requirements are kept as targets while designing steering system.
- Comprehensive test laboratory for extensive research about column performance characteristic validation, strength and durability validation and NVH requirements.
- Design team includes CAD & CAM application experts and software analysts.

»»» PRODUCTS



MANUFACTURING PLANT

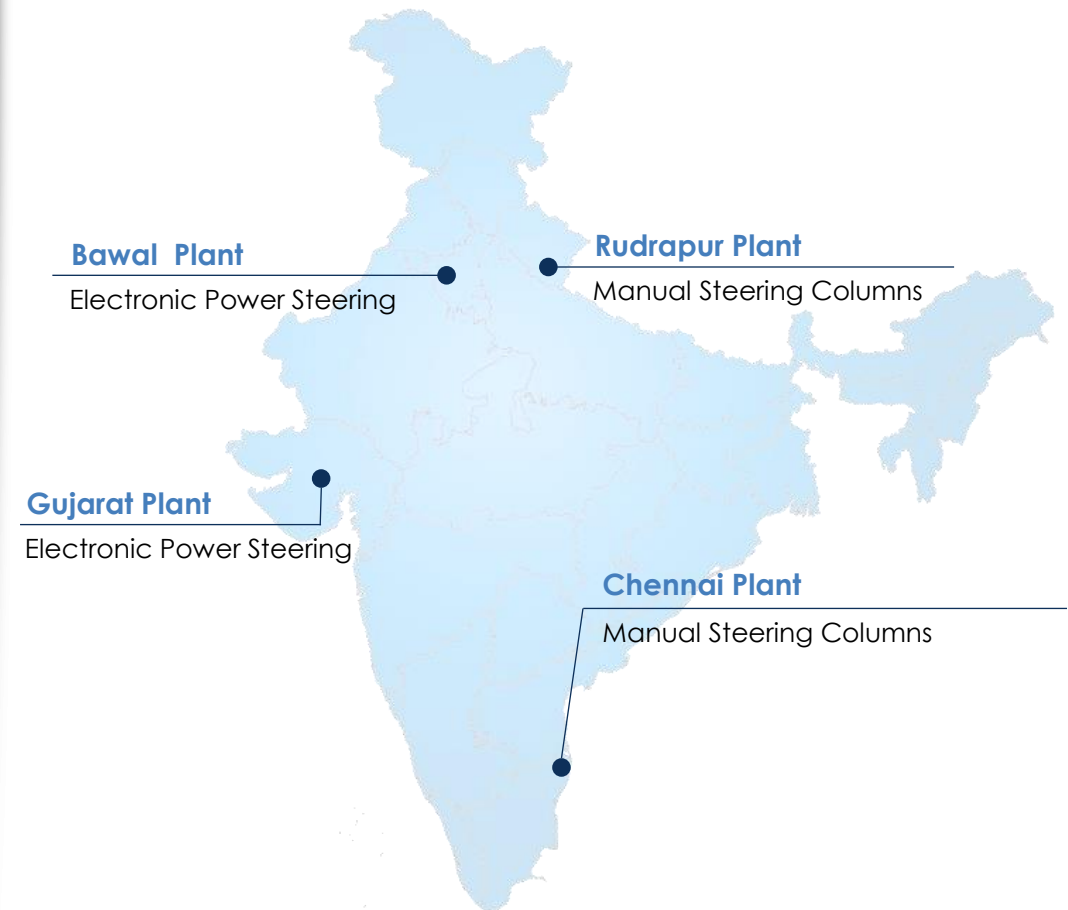

Joint venture partnership with ZF Group, Germany.

Steering Gear Division

- Design, Development and Application capability for complete Hydraulic Power Steering system for all vehicles.
- Advanced design tools for 3D modeling, simulation, FE analysis and CFD.
- State-of-the-art testing facilities for strength, environment, noise, fatigue and durability tests to meet global standards

Occupant Safety Division

- Product range includes different types of airbags, seatbelt technologies and steering wheels. Retractor and Anchor pretensioners, Emergency Locking Retractor (ELR), Load Limiters, Child Restraint Seat Belt, Driver Airbag, Passenger Airbag, Side Airbag and Curtain Airbags.
- Extensive testing facilities for seat belts include Extraction and Retraction Force Testing Machine, Retractor Durability Tester, Hot & Cold Chamber, Salt spray chamber, ELR functional tester.
- Equipped with Test lab to carry out testing as per National (IS/AIS), International (ECE/EEC/GS/VSCC), customer specifications and COP testing

PRODUCTS

Steering Gear Division



Occupant Safety Division



MANUFACTURING PLANT

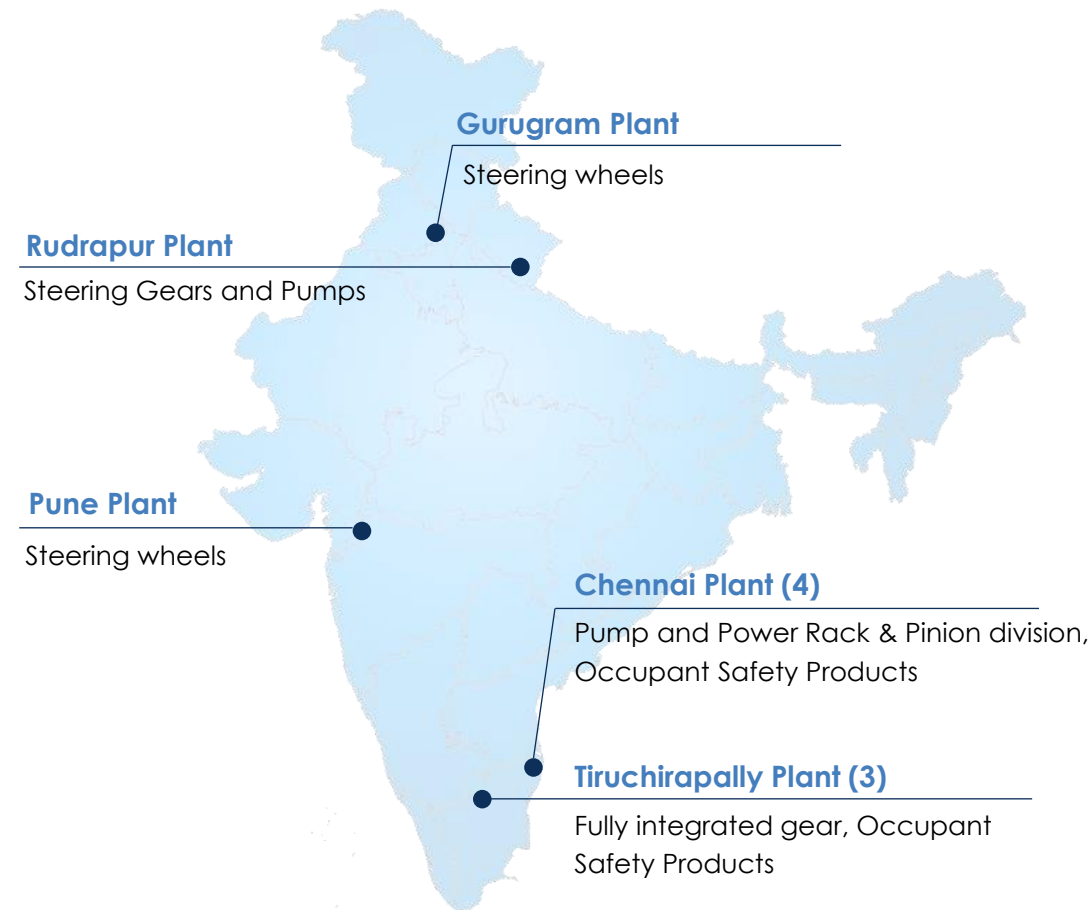

Light Metal Casting Products

Pinion Housing

Engine Timing Case Cover

Outboard Housing

Valve train Components

Engine Valves

Occupant Safety Systems

Seat Belts

Airbags

Friction Materials

Brake Lining

Disc Pad

Upper Control Arm

Stabilizer Link

Lower Control Arm

Steering & Suspension Systems

Suspension Ball Joint

Outer Ball Joint

Inner Ball Joint

Power Steering Pump

Rack & Pinion steering gear
-Mechanical
-Hydraulic

Electric Power Steering Columns

Rane (Madras)

- › Manual Steering Gears
- › Steering Linkages
- › Suspension Components
- › Light Metal Casting Products

Rane Engine Valve

- › Engine Valves

Rane Brake Lining

- › Brake Linings
- › Disc Pads

Rane Steering Systems

- › Electric Power Steering Systems

ZF Rane Automotive India

- › Hydraulic Power Steering systems
- › Seat Belts
- › Airbags

Steering & Suspension Systems



Manual Steering Column



Power Steering Gear



Power Steering Pump



Manual RCB Steering Gear



Drag Link Assembly



Tie Rod Assembly

Hydraulic Cylinder
(Twin/multi front axle trucks)



Light Metal Casting Products

Hydraulic Pump Housing



Occupant Safety Systems

Seat Belts



Friction Materials

Brake Lining



Disc Pad



Valve train Components

Valve Guides



Engine Valves

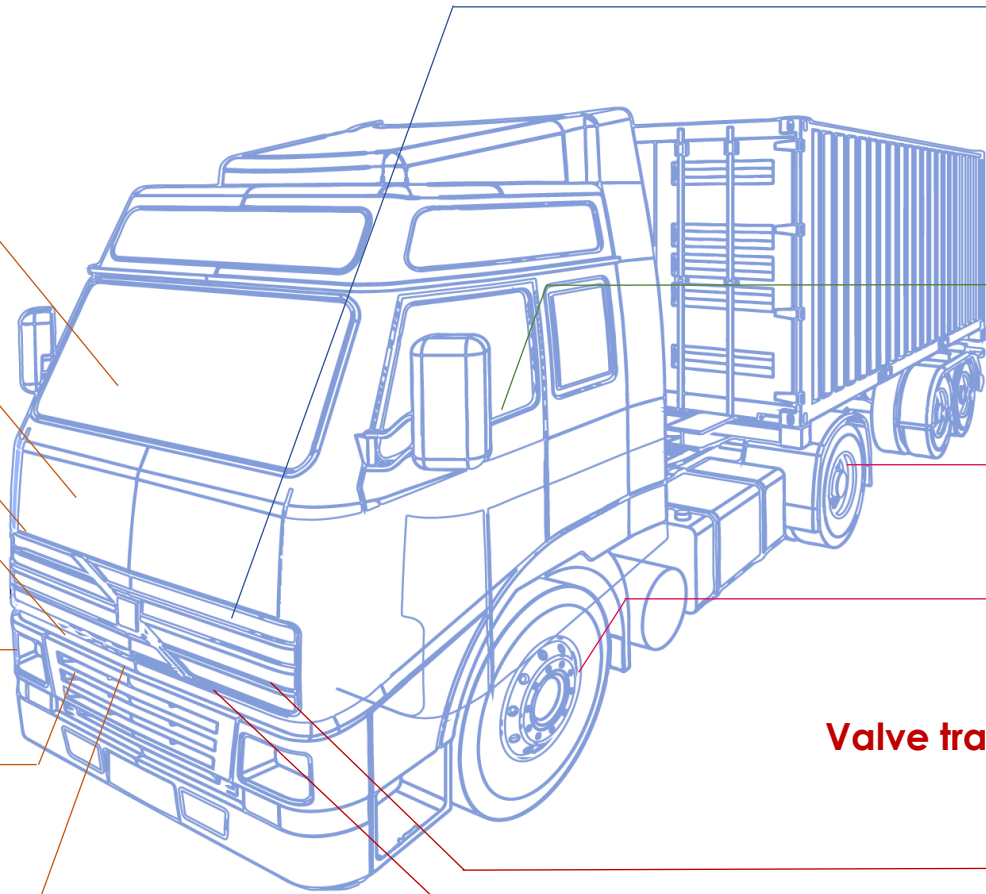

Rane (Madras)

- › Manual Steering Gears
- › Steering Linkages
- › Hydraulic Cylinders
- › Light Metal Casting Products

Rane Engine Valve

- › Engine Valves
- › Valve Guides

Rane Brake Lining

- › Brake Linings
- › Brake Pads

Rane Steering Systems

- › Manual Steering Column

ZF Rane Automotive India

- › Hydraulic Power Steering Systems
- › Seat Belts

Steering & Suspension Systems



Manual Steering /
Column
Manual RCB
Steering Gear



Hydrostatic
Steering Unit



Power Steering
Gear



Drag Link Assembly



Tie Rod Assembly

Hydraulic
Cylinder



Friction Materials

Clutch Facings



Brake Lining

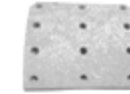

Light Metal Casting Products

Timing Case Covers



Seat Belts



Valve train components

Valve Guides



Engine Valves



Rane (Madras)

- › Manual Steering Gears
- › Steering Linkages
- › Hydraulic Cylinders
- › Hydrostatic Steering Unit
- › Light Metal Casting Products

Rane Engine Valve

- › Engine Valves
- › Valve Guides

Rane Brake Lining

- › Brake Linings
- › Clutch Facings

Rane Steering Systems

- › Manual Steering Column

ZF Rane Automotive India

- › Hydraulic Power Steering systems
- › Seat Belts

Friction Materials

Disc pad

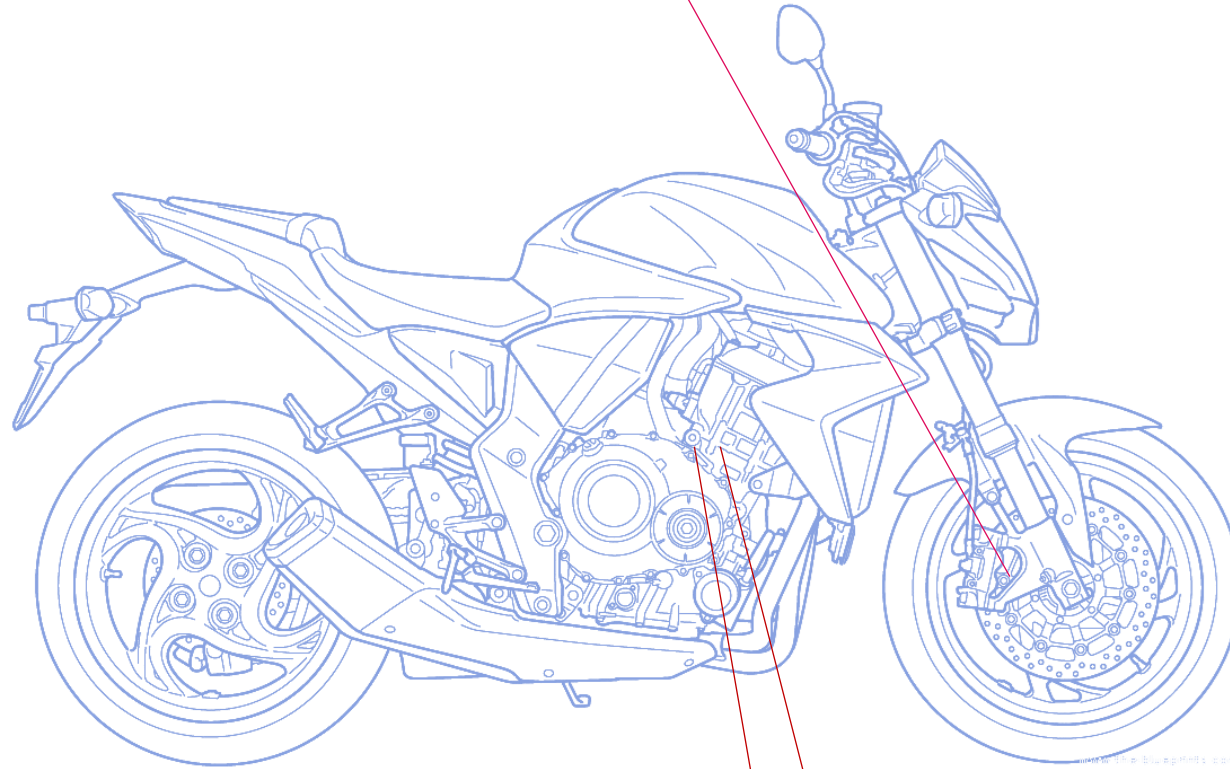

Rane Brake Lining

- › Disc Pads

Rane Engine Valve

- › Engine Valves
- › Valve Guides

Valve train Components

Valve Guides



Engine Valves



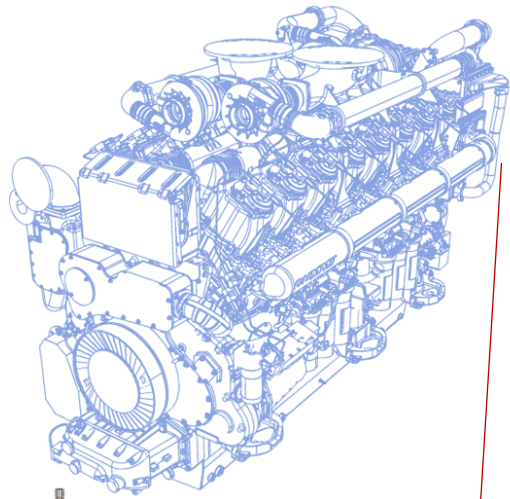

Engine Valves / Valve Guides

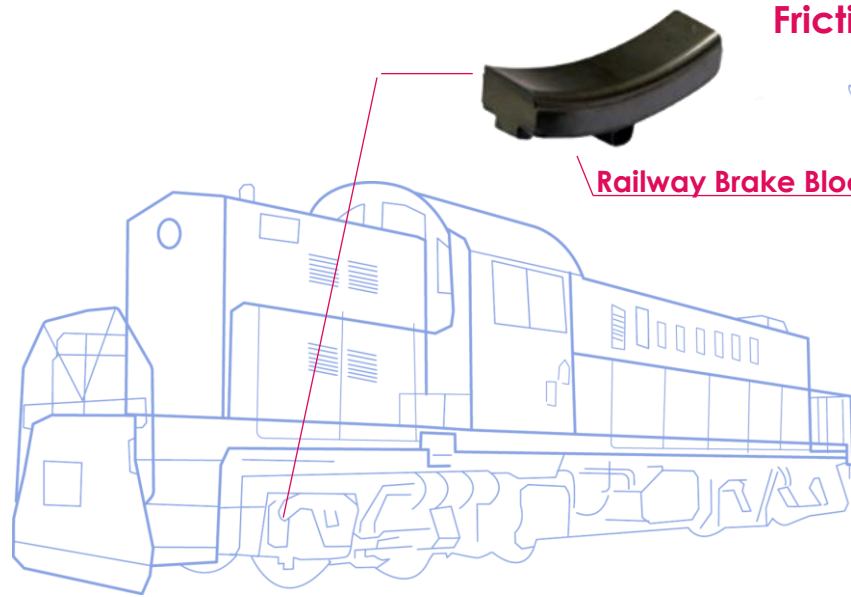
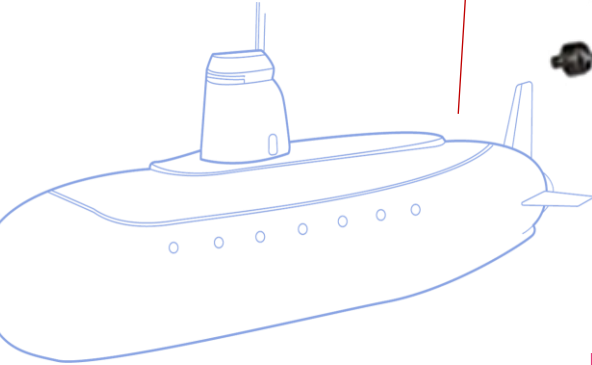

Railway Brake Block

Friction Materials

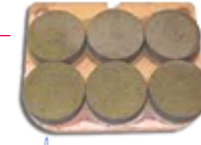

Sintered Brake Pads

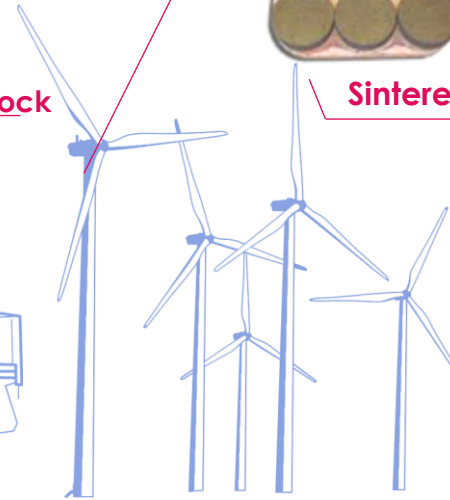

**Suspension Ball Joint
Outer Ball Joint
Inner Ball Joint**

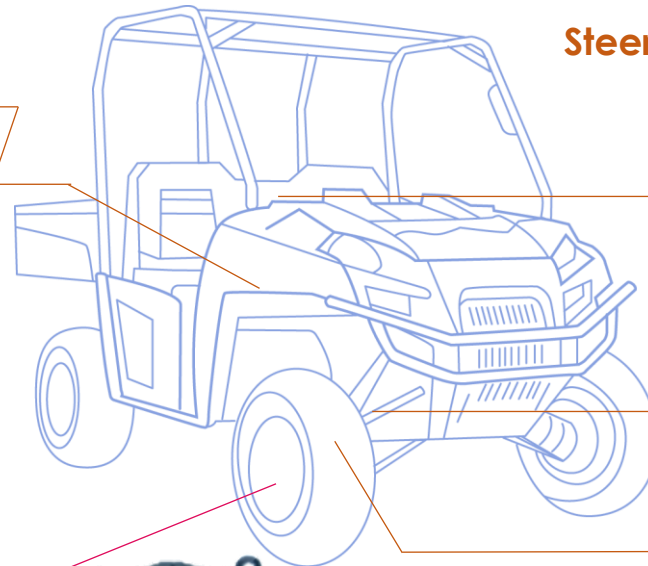

Steering & Suspension Systems



Steering Shafts



Rack & Pinion steering gear -Mechanical



Stabilizer link

**Friction Materials
Disc pad**



Rane (Madras)

- › Manual Steering Gears
- › Steering Linkages
- › Light Metal Casting Products

Rane Engine Valve

- › Engine Valves
- › Valve Guides

Rane Brake Lining

- › Sintered Brake Pads
- › Railway Brake Block

Rane Steering Systems

- › Steering Shafts

An illustrious journey of over 80 years from distributor of automobile and auto components to winner of Deming prize for manufacturing

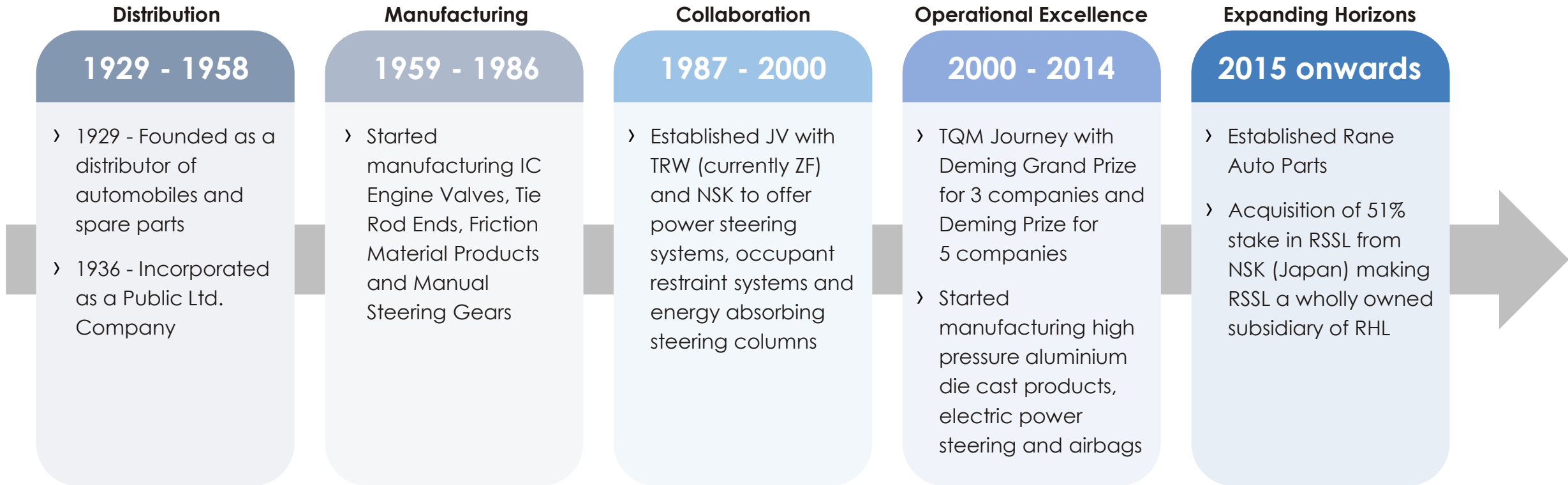



30+ Serve customers in 30+ countries

29 Manufacturing locations across India

Customer Locations Manufacturing Locations Sales Offices

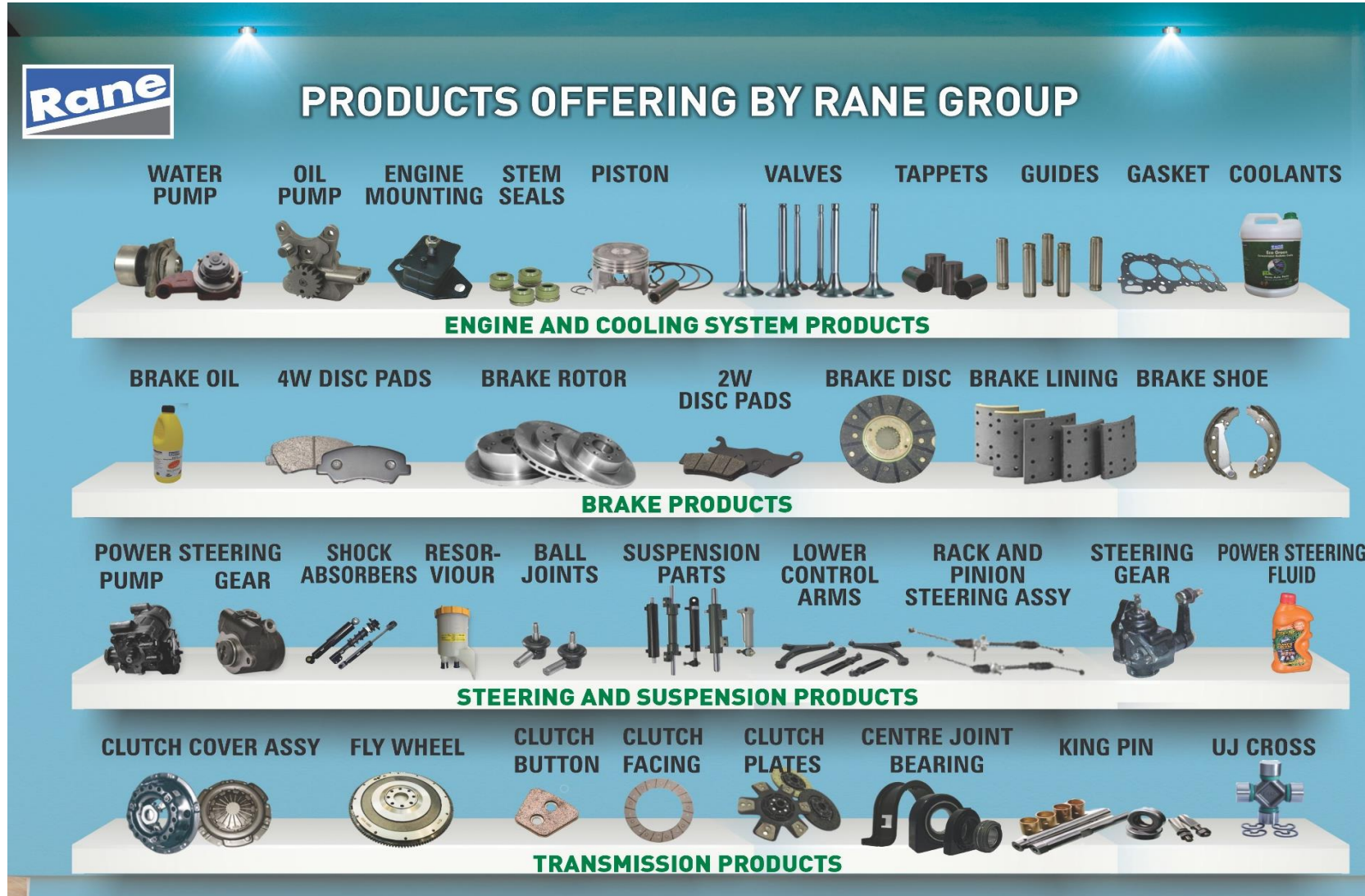

Increasing Group's brand presence in aftermarket through enhanced product portfolio and wider market reach

Strong CAE Capabilities – Design, Analysis & Simulation Software

230 R&D Engineers

42 Functional Test Rigs

26 Strength Test Rigs

62 Durability Test Rigs

33 Environmental Test Rigs

10 Noise Test Rigs



Hydraulic Power Steering Systems and Occupant Safety Systems



Energy Absorbing Steering Columns and Electric Power Steering



Brake Linings, Discs Pads and Clutch Facings

We create and deliver value to our customers

INDIA

Passenger Vehicle



Commercial Vehicle



Farm Tractor



Two/Three-Wheeler



Other Applications



INTERNATIONAL



‘Customer at the core’ remains our priority on the goal to sustainable growth and profitability



Rane Group

Customer	Award Category
Mahindra & Mahindra	Business Partner of the year – Automotive Division
Ki Mobility Solutions	Partnership of Excellence



Rane (Madras)

Customer	Award Category
Volvo Eicher	New Product Development Award
Nexteer TAFE	Perfect Quality Award Best Supplier & Benchmark Award
Maruti Suzuki	Superior Performance Award, Special Support
SML Isuzu	New Product Development Award
Tata Motors	Award for Exceptional Support, Best Supplier – Demand Fulfillment, Sustainability Excellence
Toyota Industries	Best Target Achieved Supplier Award
Polaris	Supplier of Excellence
Daimler India	Reliable Partner & Achieving 100% in delivery



Rane Engine Valve

Customer	Award Category
Groupe Renault	Quality & Customer Satisfaction
John Deere India	Quality Appreciation Award
Volvo Eicher	Quality & Delivery excellence
Renault Nissan	Quality & Customer Satisfaction
Hyundai	Appreciation Award
Cummins India	Superior Quality Award



ZF Rane

Customer	Award Category
Ashok Leyland	Best Performance in Business Alignment-Gold
Isuzu Motors	Most Improved Supplier Award
Tata Motors	Best Supplier Award, Efficiency Award, Best in Class Award
Volvo Eicher	Best Supplier in NPD, Supply Chain, Uptime Excellence
Daimler India	Quality Appreciation Award, Q Prime Supplier
Renault Nissan	Best Supplier in Field Quality



Rane Brake Lining

Customer	Award Category
Brakes India	Best Supplier - Friction
Ashok Leyland	After Market Support Award
Foundation Brake	Business Excellence Award
Endurance	Gold Award for Quality Best Benchmark Award, Best Supplier Award, Consistent Vendor Rating Performance Award



Rane Steering Systems

Customer	Award Category
Maruti Suzuki	Efforts in Vendor Import Localisation
Honda Cars	Award for best reduction in CO2
Volvo Eicher	Quality Excellence, Supply Chain Management
Daimler India	Best Technology Support

Rane Values

- › Provide superior products and maintain market leadership
- › Pursue excellence
- › Achieve the highest standard of ethics and integrity

Rane Approach

- › Build strong connections with customers to understand their challenges
- › Strategic investments to improve quality and productivity
- › TQM way of working
- › Emphasis on 'First-time right' policy

Rane Credentials

- › Modern manufacturing facilities with IATF 16949 certification
- › State-of-the-art product development and validation capabilities
- › Deming Grand Prize for 3 Rane companies
- › Deming Prize for 5 Rane companies



- › Technology collaboration with top global players



ZF Group, Germany
Hydraulic Power Steering Systems and Occupant Safety Systems



NSK, Japan
Energy Absorbing Steering Columns and Electric Power Steering



Nisshinbo Brake Inc., Japan
Brake Linings, Disc Pads and Clutch Facings

Value Proposition

- › Superior products driven by execution excellence
- › Trusted partner with shorter development lead times
- › Agile manufacturing process and scalable facilities
- › Provide system-level solutions with deep understanding of customer needs
- › With enhanced R&D capabilities, we provide light-weighting, improved safety and performance

**LONG TERM PARTNER OF CHOICE TO LEADING
AUTOMOTIVE COMPANIES AND TIER 1 SUPPLIERS**

An exciting workplace founded on the principles of values, fairness and transparency that:



Provides challenging assignments

Encourages learning

Enhances career opportunities



- › **Organisation Development Excellence Award** for the exceptional practices on **Leadership Development** by Transcendence, Tata Institute of Social Sciences (TISS), 2019
- › Recognized by International Federation of Training and Development Organizations in Best HRD practice category, 2018
- › Award for **Talent Management** from the Employer Branding institute, Singapore, 2012 & 2014
- › Significant Achievement in **HR Excellence**, CII, 2012



Certified as a **Great Workplace** by the Great Place to Work institute, 2024



Systems approach to deliver H&S to our employees

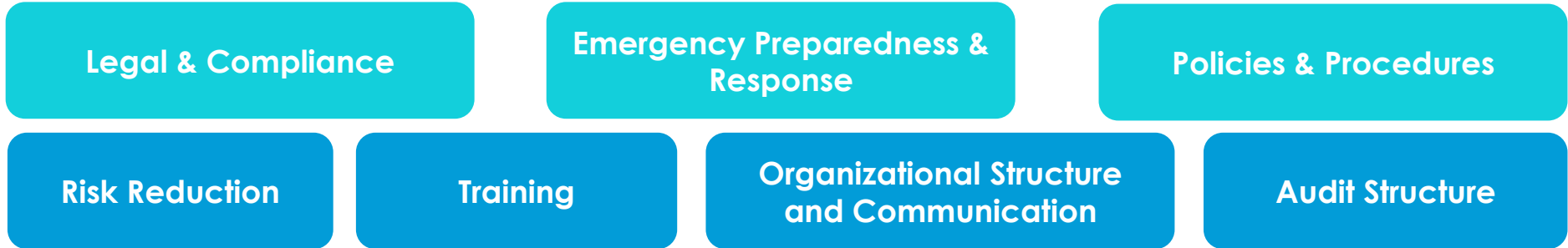

- › Rane Foundation (RF) is a **public charitable trust** founded by Rane's promoters in the year 1967
- › RF is the **main arm for Rane's Corporate Social Responsibility (CSR) initiatives** and is exclusively funded by the Rane companies
- › Initiatives are focused on **education, healthcare, environment and community development**

Rane Polytechnic



Education

- › Institution Development - Rane Polytechnic, Rane Vidyalaya
- › Vocational Training & Skill Development
- › Awareness programs



Healthcare

- › Nutrition program
- › Health camps
- › Medical infrastructure & aid



Environment

- › Plantation drives
- › Infrastructure for sustainability
- › Natural resource preservation



Community Development

- › Providing amenities & sanitation
- › Improving quality of life
- › Rural infrastructure development program

Rane Vidyalaya



Thank You

For further information, please contact:

investorservices@ranegroup.com or diwakar.pingle@in.ey.com

Rane Corporate Centre

"Maithri" 132, Cathedral Road,
Chennai - 600 086, India
www.ranegroup.com

Glossary of Abbreviations

Abbreviation	Expansion	Abbreviation	Expansion
ACMA	Automotive Component Manufacturers Association	OEM	Original Equipment Manufacturer
AMP	Advanced Machining Processes	OES	Original Equipment Supplier
ATV	All Terrain Vehicle	OSD	Occupancy Safety Division
bps	Basis point, 100 bps equal to 1%	PC	Passenger Car
CII	Confederation of Indian Industry	PV	Passenger vehicle
Cr	Crores	QC	Quality Control
CV	Commercial Vehicle	R&D	Research and development
ELR	Emergency Locking Retractor	RBL	Rane Brake Lining Limited
EPS	Earnings per share / Electronic power steering	REVL	Rane Engine Valve Limited
EV	Electric vehicle	RHL	Rane Holdings Limited
FT	Farm Tractors	RML	Rane (Madras) Limited
FY	Financial Year	RSSL	Rane Steering Systems Pvt Limited
HPDC	High Pressure Die Casting	SCV	Small Commercial vehicle
HR	Human Resource	SE	Station Engine
Intl	International	SGD	Steering Gear Division
JV	Joint Venture	TPM	Total Productive Maintenance
LCV	Light Commercial Vehicles	US	United States
LMCA	Light Metal Casting Inc., America	USD	United States Dollar
Ltd	Limited	VRS	Voluntary Retirement Scheme
M&HCV	Medium & Heavy Commercial Vehicles	YoY	Year-on-Year
MUV	Multi Utility Vehicle	ZRAI	ZF Rane Automotive India Pvt limited
NPD	New Product Development	2W/3W/4W	Two Wheeler/Three Wheeler/Four Wheeler
OE	Original Equipment		

This presentation may contain certain forward looking statements concerning Rane's future business prospects and business profitability, which are subject to a number of risks and uncertainties and the actual results could materially differ from those in such forward looking statements. The risks and uncertainties relating to these statements include, but not limited to risks and uncertainties regarding fluctuations in earnings, our ability to manage growth, competition (both domestic and international), economic growth in India and the target countries for exports, ability to attract and retain highly skilled professionals, government policies and action with respect to investments, fiscal deficits, regulations etc., interest and other fiscal costs generally prevailing in the economy. The company does not undertake to make any announcement in case any of these forward looking statement become materially incorrect in future or update any forward looking statements made from time to time by or on behalf of the Company.